

## Pareti doppiovetro/Double-glass partitions

P 6,4

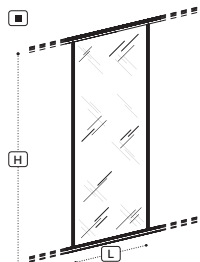

Moduli vetro/Glass partitions

P 6,4

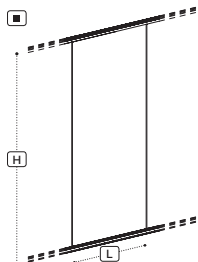

Moduli ciechi / Panelled partitions

L 22,5 x P 6,6

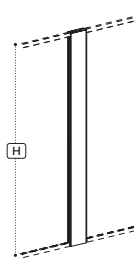

Modulo tecnico per passaggio cavi  
/ Wire management technical module

## Profili per moduli vetro ad angolo/Glass module corner profiles

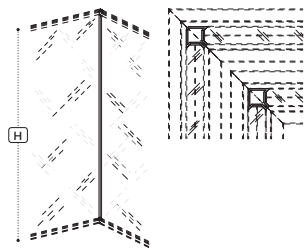

Per modulo angolo 90° a 2 vie  
/For 2 way 90° corner module

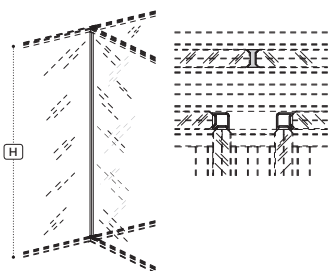

Per modulo angolo 90° a 3 vie  
/For 3 way 90° corner module

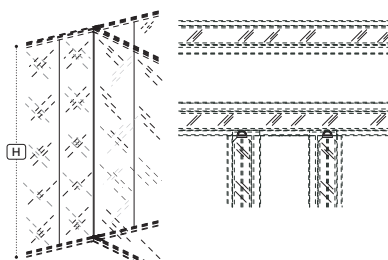

Per modulo angolo 90° a 3 vie  
/For 3 way 90° corner module

## Profili/Profiles

L 4,5 P 6,4

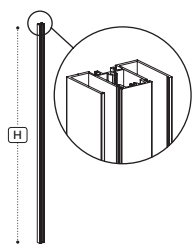

Profilo di partenza fisso  
/Fixed start profile

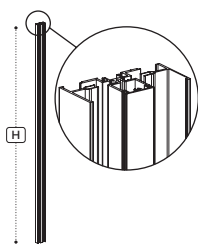

Profilo di chiusura con  
elemento mobile/End profile  
with movable element

L 1,6 P 6,4

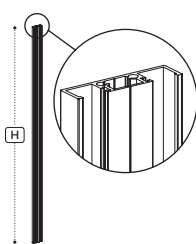

Profilo terminale  
/Terminal profile

L 3 P 6,4

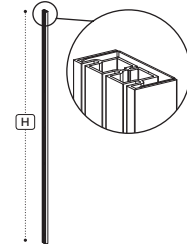

Profilo terminale telescopico  
/Telescopic terminal profile

## Porte/Doors

L 95 P 6,4

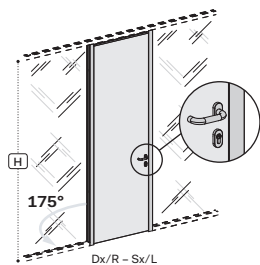

Porta anta battente cieca  
/Single hinged panelled door

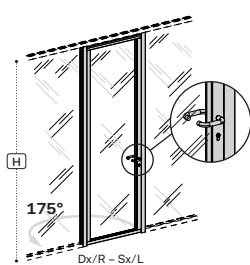

Porta anta battente vetro  
/Single hinged glass door

L 171 P 6,4

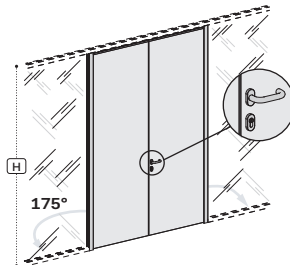

Porta doppia anta battente cieca  
/Double hinged panelled door

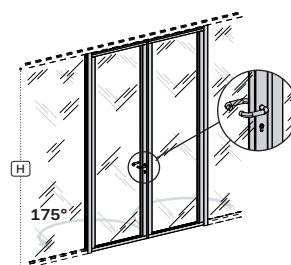

Porta doppia anta battente vetro  
/Double hinged glass door

Porte scorrevoli/Sliding doors

L 95 P 6,4

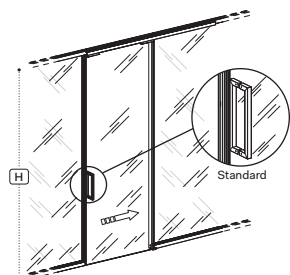

Porta scorrevole con anta in vetro  
/Glass sliding door

L 95 P 6,4

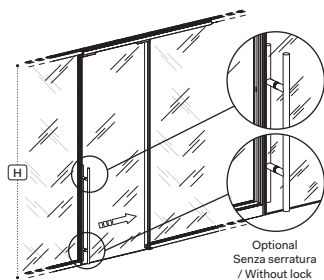

Porta scorrevole con anta in vetro  
/Glass sliding door

L 95 P 6,4

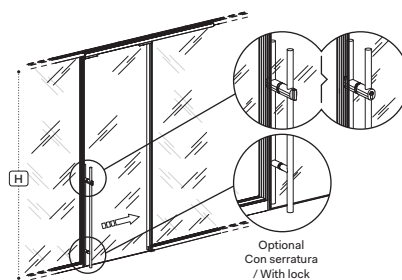

Porta scorrevole con anta in vetro  
/Glass sliding door

L 190 P 6,4

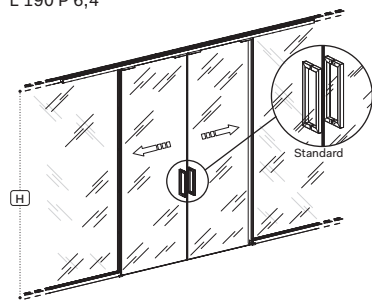

Porta scorrevole doppia anta in vetro  
/Double sliding glass door

L 190 P 6,4

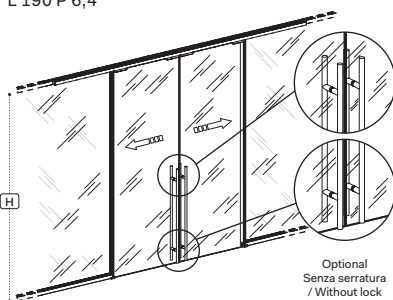

Porta scorrevole doppia anta in vetro  
/Double sliding glass door

L 190 P 6,4

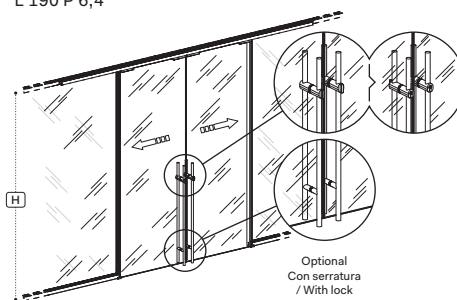

Porta scorrevole doppia anta in vetro  
/Double sliding glass door

Note:

1 Le dimensioni sono espresse in cm - consultare il listino prezzi per le caratteristiche tecniche, i codici degli articoli e delle finiture/Dimensions are stated in cm - for technical characteristics, article code numbers and finishing see price list;

2 La quotazione delle pareti monovetro verrà effettuata in base ai m<sup>2</sup> richiesti (H×L)/The quotation of the mono-glass partitions will be calculated according the required square meters (H×L).